



LEISTUNGSERKLÄRUNG



Nr. 0006 – DE

1. Eindeutiger Kenncode des Produkttyps: **fischer Injektionssystem FIS GREEN**

2. Verwendungszweck(e):

| Produkt | Verwendungszweck (e) |
|--|---|
| Metalldübel zur Verwendung im Beton (hoch belastbar) | Zur Verankerung und/oder Unterstützung tragender Betonelemente oder schwerer Bauteile wie Bekleidungen und Unterdecken , siehe Anhang, insbesondere Anhänge B 1 bis B 8 |

3. Hersteller: **fischerwerke GmbH & Co. KG, Otto-Hahn-Straße 15, 79211 Denzlingen, Deutschland**

4. Bevollmächtigter: --

5. System(e) zur Bewertung und Überprüfung der Leistungsbeständigkeit: **1**

6a. Harmonisierte Norm: ---

Notifizierte Stelle(n): ---

6b. Europäisches Bewertungsdokument: **ETAG 001; 2013-04**

Europäische Technische Bewertung: **ETA-14/0408; 2014-12-19**

Technische Bewertungsstelle: **DIBt**

Notifizierte Stelle(n): **1343 – MPA Darmstadt**

7. Erklärte Leistung(en):

Mechanische Festigkeit und Standsicherheit (BWR 1)

| Wesentliches Merkmal | Leistung |
|---|---|
| Charakteristische Werte für Bemessung nach TR 029 | Siehe Anhang, insbesondere Anhänge C 1 bis C 5 |
| Charakteristische Werte für Bemessung nach CEN/TS 1992-4:2009 | Siehe Anhang, insbesondere Anhänge C 6 bis C 11 |
| Verschiebungen unter Zuglast und Querlast | Siehe Anhang, insbesondere Anhänge C 12, C 13 |

Brandschutz (BWR 2)

| Wesentliches Merkmal | Leistung |
|----------------------|---|
| Brandverhalten | Der Dübel erfüllt die Anforderungen der Klasse A1 |
| Feuerwiderstand | Keine Leistung festgestellt (KLF) |

8. Angemessene Technische Dokumentation und/oder Spezifische Technische Dokumentation: ---

Die Leistung des vorstehenden Produkts entspricht der erklärten Leistung/den erklärten Leistungen. Für die Erstellung der Leistungserklärung im Einklang mit der Verordnung (EU) Nr. 305/2011 ist allein der obengenannte Hersteller verantwortlich.

Unterzeichnet für den Hersteller und im Namen des Herstellers von:

Andreas Bucher, Dipl.-Ing.

Wolfgang Hengesbach, Dipl.-Ing., Dipl.-Wirtsch.-Ing.

Tumlingen, 2014-12-22

- Diese Leistungserklärung wurde in verschiedenen Sprachversionen erstellt. Für den Fall unterschiedlicher Auslegung hat immer die englische Version Vorrang.
- Der Anhang enthält freiwillige und ergänzende Informationen in englischer Sprache. Diese gehen über die (sprachneutral angegebenen) gesetzlichen Anforderungen hinaus.

Specific Part

1 Technical description of the product

The fischer injection system FIS GREEN is a bonded anchor consisting of a cartridge with injection mortar fischer FIS GREEN and a steel element. The steel element consist of

- a fischer threaded rod with washer and hexagon nut of sizes M8 to M20 or
- internal threaded anchor RG MI of sizes M8 to M16 or
- a deformed reinforcing bar of sizes $\phi = 8$ to 20 mm or
- a fischer rebar anchor FRA of sizes M12 to M20

The steel element is placed into a drilled hole filled with injection mortar and is anchored via the bond between metal part, injection mortar and concrete.

The product description is given in Annex A.

2 Specification of the intended use in accordance with the applicable European Assessment Document

The performances given in Section 3 are only valid if the anchor is used in compliance with the specifications and conditions given in Annex B.

The verifications and assessment methods on which this European Technical Assessment is based lead to the assumption of a working life of the anchor of at least 50 years. The indications given on the working life cannot be interpreted as a guarantee given by the producer, but are to be regarded only as a means for choosing the right products in relation to the expected economically reasonable working life of the works.

3 Performance of the product and references to the methods used for its assessment

3.1 Mechanical resistance and stability (BWR 1)

| Essential characteristic | Performance |
|--|-----------------------|
| Characteristic resistance for design according to TR 029 | See Annex C 1 to C 5 |
| Characteristic resistance for design according to CEN/TS 1992-4:2009 | See Annex C 6 to C 11 |
| Displacements under tension and shear loads | See Annex C 12 / C 13 |

3.2 Safety in case of fire (BWR 2)

| Essential characteristic | Performance |
|--------------------------|---|
| Reaction to fire | Anchorage satisfy requirements for Class A1 |
| Resistance to fire | No performance determined (NPD) |

3.3 Hygiene, health and the environment (BWR 3)

Regarding dangerous substances there may be requirements (e.g. transposed European legislation and national laws, regulations and administrative provisions) applicable to the products falling within the scope of this European Technical Assessment. In order to meet the provisions of Regulation (EU) No 305/2011, these requirements need also to be complied with, when and where they apply.

3.4 Safety in use (BWR 4)

The essential characteristics regarding Safety in use are included under the Basic Works Requirement Mechanical resistance and stability.

3.5 Protection against noise (BWR 5)

Not applicable.

3.6 Energy economy and heat retention (BWR 6)

Not applicable.

3.7 Sustainable use of natural resources (BWR 7)

The sustainable use of natural resources was not investigated.

3.8 General aspects

The verification of durability is part of testing the essential characteristics. Durability is only ensured if the specifications of intended use according to Annex B are taken into account.

4 Assessment and verification of constancy of performance (AVCP) system applied, with reference to its legal base

According to Decision of the Commission of 24 June 1996 (96/582/EC) (OJ L 254 of 08.10.96 p. 62-65), the system of assessment and verification of constancy of performance (see Annex V and Article 65 Paragraph 2 to Regulation (EU) No 305/2011) given in the following table applies.

| Product | Intended use | Level or class | System |
|---|--|-----------------------|---------------|
| Metal anchors for use in concrete (heavy-duty type) | For fixing and/or supporting concrete structural elements or heavy units such as cladding and suspended ceilings | — | 1 |

Installed condition

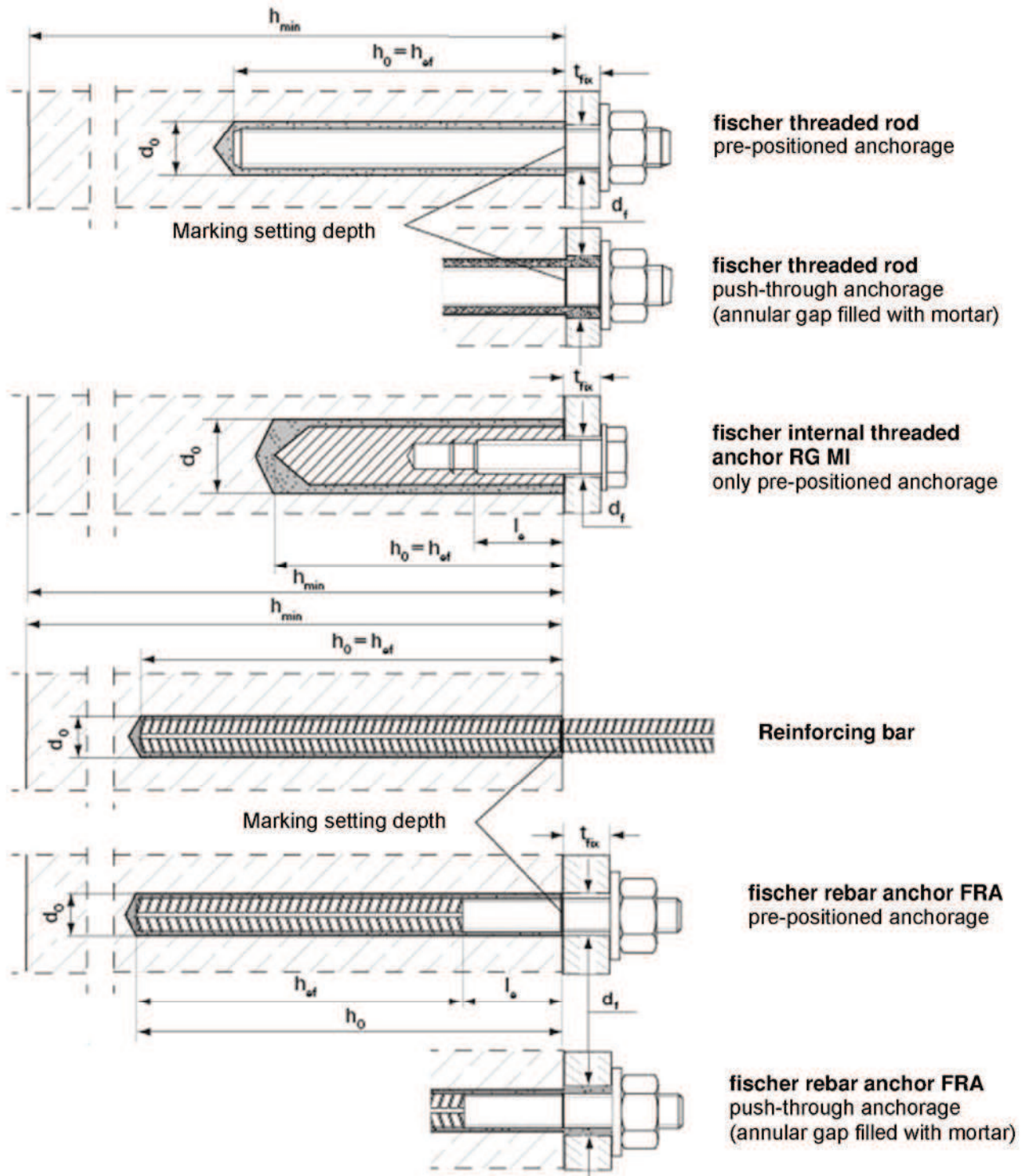

fischer Injectionsystem FIS GREEN

Product description
Installed condition

Annex A 1

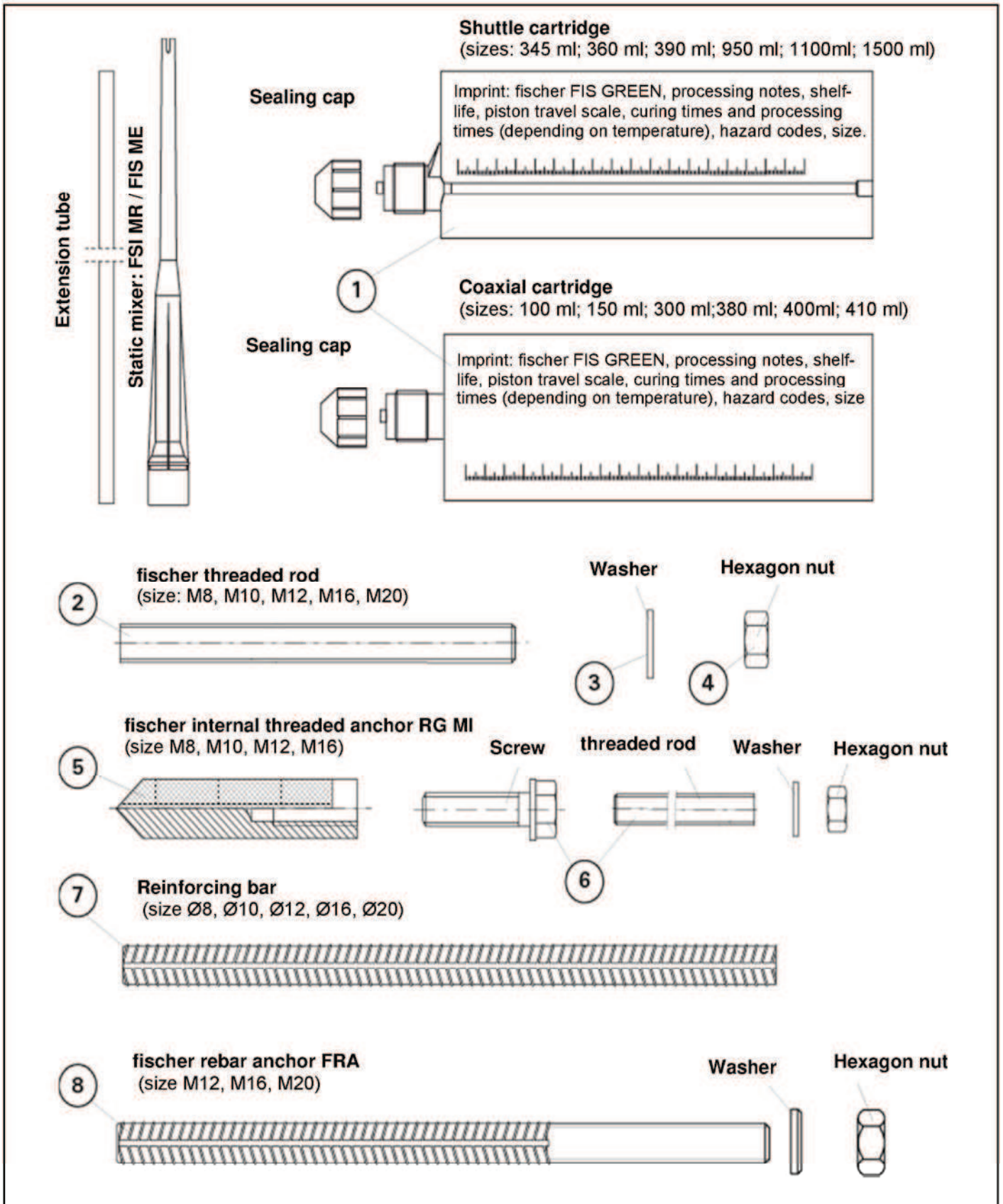

| | |
|--|-------------------------|
| <p>fischer Injectionsystem FIS GREEN</p> | <p>Annex A 2</p> |
| <p>Product description Cartridges, Static mixer, Steel elements</p> | |

Table A1: Materials

| Part | Designation | Material | | |
|------|---|--|---|---|
| 1 | Mortar cartridge | Bio based mortar, hardener; fillers | | |
| | | Steel, zinc plated | Stainless steel A4 | High corrosion-resistant steel C |
| 2 | Threaded rod | Property class 5.8 or 8.8; ISO 898-1:2013 zinc plated $\geq 5\mu\text{m}$, ISO 4042:1999 A2K or hot-dip galvanised ISO 10684:2004 $f_{uk} \leq 1000 \text{ N/mm}^2$ $A_5 > 8\%$ | Property class 50, 70 or 80 ISO 3506:2009 1.4401; 1.4404; 1.4578; 1.4571; 1.4439; 1.4362; 1.4062 EN 10088-1:2014 $f_{uk} \leq 1000 \text{ N/mm}^2$ $A_5 > 8\%$ | Property class 50 or 80 ISO 3506:2009 or property class 70 with $f_{yk} = 560 \text{ N/mm}^2$ 1.4565; 1.4529 EN 10088-1:2014 $f_{uk} \leq 1000 \text{ N/mm}^2$ $A_5 > 8\%$ |
| 3 | Washer ISO 7089:2000 | zinc plated $\geq 5\mu\text{m}$, EN ISO 4042:1999 A2K or hot-dip galvanised ISO 10684:2004 | 1.4401; 1.4404; 1.4578; 1.4571; 1.4439; 1.4362 EN 10088-1:2014 | 1.4565; 1.4529 EN 10088-1:2014 |
| 4 | Hexagon nut | Property class 5 or 8; ISO 898-2:2013 zinc plated $\geq 5\mu\text{m}$, ISO 4042:1999 A2K or hot-dip galvanised ISO 10684:2004 | Property class 50, 70 or 80 ISO 3506:2009 1.4401; 1.4404; 1.4578; 1.4571; 1.4571; 1.4439; 1.4362 EN 10088-1:2014 | Property class 50, 70 or 80 ISO 3506:2009 1.4565; 1.4529 EN 10088-1:2014 |
| 5 | Internal threaded anchor RG MI | Property class 5.8 or 8.8; EN 10277-1:2008-06 zinc plated $\geq 5\mu\text{m}$, ISO 4042:1999 A2K | Property class 70 ISO 3506:2009 1.4401; 1.4404; 1.4578; 1.4571; 1.4439; 1.4362 EN 10088-1:2014 | Property class 70 ISO 3506-1:2009 1.4565; 1.4529 EN 10088-1:2014 |
| 6 | Screw or threaded rod for internal threaded anchor | Property class 5.8 or 8.8; ISO 898-1:2013 zinc plated $\geq 5\mu\text{m}$, ISO 4042:1999 A2K | Property class 70 ISO 3506:2009 1.4401; 1.4404; 1.4578; 1.4571; 1.4439; 1.4362 EN 10088-1:2014 | Property class 70 ISO 3506-1:2009 1.4565; 1.4529 EN 10088-1:2014 |
| 7 | Rebar EN 1992-1-1:2004 + AC:2010, Annex C | Bars and decoiled rods class B or C with f_{yk} and k according to NDP or NCL of EN 1992-1-1/NA:2013 $f_{uk} = f_{tk} = k \cdot f_{yk}$ | | |
| 8 | Rebar anchor FRA | Bars and decoiled rods class B or C with f_{yk} and k according to NDP or NCL of EN 1992-1-1/NA:2013 $f_{uk} = f_{tk} = k \cdot f_{yk}$ Threaded part: Property class 70 ISO 3506:2009 1.4565; 1.4529 EN 10088-1:2014 | | |

fischer Injectionsystem FIS GREENProduct description
Materials**Annex A 3**

Specifications of intended use**Anchorage subject to:**

- Static and quasi-static loads.

Base materials:

- Reinforced or unreinforced normal weight concrete according to EN 206:2013 .
- Strength classes C20/25 to C50/60 according to EN 206:2013.
- Non-cracked concrete.

Temperature ranges:

| | Max. long term temperature | Max. short term temperature |
|--|----------------------------|-----------------------------|
| Temperature range I -40°C to +40°C | +24°C | +40°C |
| Temperature range II -40°C to +80°C | +50°C | +80°C |

Use conditions (Environmental conditions):

- Structures subject to dry internal conditions (zinc coated steel, stainless steel or high corrosion resistant steel)
- Structures subject to external atmospheric exposure (including industrial and marine environment) and to permanently damp internal condition, if no particular aggressive conditions exist (stainless steel or high corrosion resistant steel)
- Structures subject to external atmospheric exposure and to permanently damp internal condition, if other particular aggressive conditions (high corrosion resistant steel)
Note: Particular aggressive conditions are e.g. permanent, alternating immersion in seawater or the splash zone of seawater, chloride atmosphere of indoor swimming pools or atmosphere with extreme chemical pollution (e.g. in desulphurization plants or road tunnels where de-icing materials are used).

Design:

- Anchorages have to be designed under the responsibility of an engineer experienced in anchorages and concrete work.
- Verifiable calculation notes and drawings have to be prepared taking account of the loads to be anchored. The position of the anchor is indicated on the design drawings (e.g. position of the anchor relative to reinforcement or to supports, etc.).
- Anchorages under static or quasi-static actions have to be designed in accordance with TR 029 "Design of bonded anchors", Edition September 2010 or CEN/TS 1992-4:2009

Installation:

- Anchor installation carried out by appropriately qualified personnel and under the supervision of the person responsible for technical matters of the site.
- Dry or wet concrete.
- Hole drilling by hammer mode.
- In case of aborted hole: The hole shall be filled with mortar
- Marking and keeping the effective anchorage depth
- Cleaning the drill hole and installation in accordance with Annexes B 7 to B 8
- During curing of the mortar the temperature of the concrete must not fall below 0°C
- The curing time until the anchor may be loaded as given in Annex B 6 Table B6

fischer Injectionsystem FIS GREENIntended use
Specifications**Annex B 1**

Table B1: Installation parameters threaded rods

| Anchor size | | | M8 | M10 | M12 | M16 | M20 | |
|---|--------------------------|-----------|----------------|--------------------------|-----|-----|-----------------|----|
| Nominal drill hole diameter | d_0 | [mm] | 10 | 12 | 14 | 18 | 24 | |
| Width across flat | SW | [mm] | 13 | 17 | 19 | 24 | 30 | |
| Drill hole depth | h_0 | [mm] | $h_0 = h_{ef}$ | | | | | |
| Effective anchorage depth | $h_{ef,min}$ | [mm] | 60 | 60 | 70 | 80 | 90 | |
| | $h_{ef,max}$ | [mm] | 160 | 200 | 240 | 320 | 400 | |
| Maximum torque moment | $T_{inst,max}$ | [Nm] | 10 | 20 | 40 | 60 | 120 | |
| Minimum spacing | s_{min} | [mm] | 40 | 45 | 55 | 65 | 85 | |
| Minimum edge distance | c_{min} | [mm] | 40 | 45 | 55 | 65 | 85 | |
| Diameter of clearance hole in the fixture ¹⁾ | Pre-positioned anchorage | d_f | [mm] | 9 | 12 | 14 | 18 | 22 |
| | Push-through anchorage | d_f | [mm] | 11 | 14 | 16 | 20 | 26 |
| Minimum thickness of concrete member | | h_{min} | [mm] | $h_{ef} + 30 (\geq 100)$ | | | $h_{ef} + 2d_0$ | |

¹⁾ For bigger clearance holes in fixture see TR 029, chapter 1.1 or CEN/TS 1992-4-1, chapter 1.2.3

fischer threaded rod FIS A and RGM

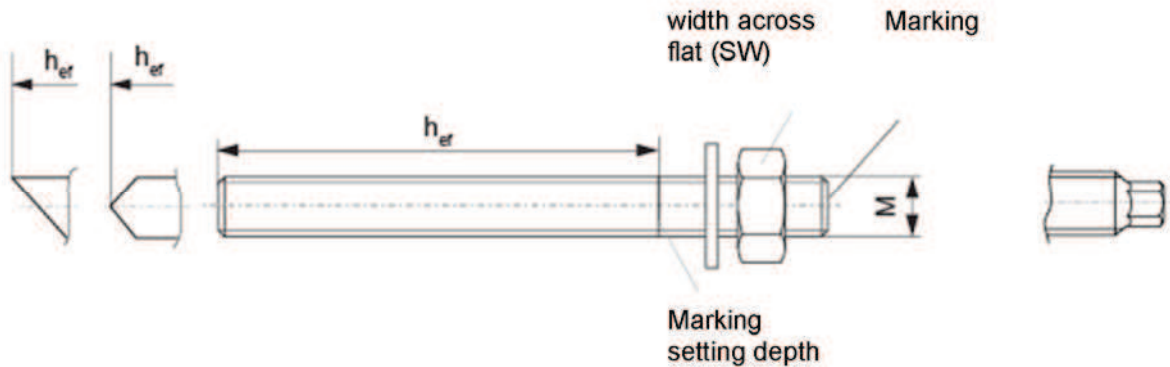

Marking:

- Property class 8.8 or high corrosion-resistant steel C, property class 80: •
- Stainless steel A4, property class 50 and high corrosion-resistant steel C, property class 50: ••

Commercial standard threaded rods, washers and hexagon nuts may also be used if the following requirements are fulfilled:

- Materials, dimensions and mechanical properties according Annex A 3, Table A1
- Inspection certificate 3.1 according to EN 10204:2004, the documents should be stored
- Marking of embedment depth

fischer Injectionsystem FIS GREEN

Intended use
Installation parameters threaded rods

Annex B 2

Table B2: Installation parameters internal threaded anchors RG MI

| Nominal size | | | M8 | M10 | M12 | M16 |
|---|----------------|------|----------------|-----|-----|-----|
| Anchor size | d_H | [mm] | 12 | 16 | 18 | 22 |
| Nominal drill hole diameter | d_0 | [mm] | 14 | 18 | 20 | 24 |
| Drill hole depth | h_0 | [mm] | $h_0 = h_{ef}$ | | | |
| Effective anchorage depth | h_{ef} | [mm] | 90 | 90 | 125 | 160 |
| Maximum torque moment | $T_{inst,max}$ | [Nm] | 10 | 20 | 40 | 80 |
| Minimum spacing | s_{min} | [mm] | 55 | 65 | 75 | 95 |
| Minimum edge distance | c_{min} | [mm] | 55 | 65 | 75 | 95 |
| Diameter of clearance hole in the fixture ¹⁾ | d_f | [mm] | 9 | 12 | 14 | 18 |
| Minimum thickness of concrete member | h_{min} | [mm] | 120 | 126 | 165 | 208 |
| Maximum screw-in depth | $l_{E,max}$ | [mm] | 18 | 23 | 26 | 35 |
| Minimum screw-in depth | $l_{E,min}$ | [mm] | 8 | 10 | 12 | 16 |

¹⁾ For bigger clearance holes in fixture see TR 029, chapter 1.1 or CEN/TS 1992-4-1, chapter 1.2.3

fischer internal threaded anchor RG MI

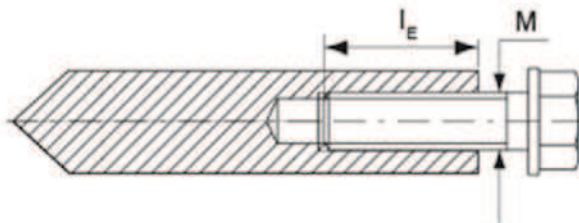

Marking: anchor size e.g.: M10
 Stainless steel in addition A4 e.g.: M10
 A4High corrosion-resistant steel in addition C
 e.g.: M10 C

Marking

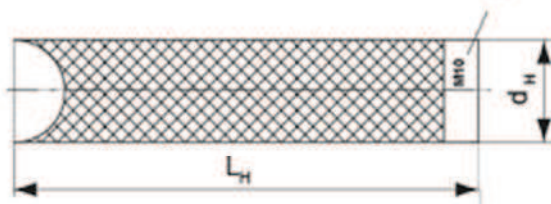

Fastening screw or threaded rods including washer and nuts must comply with the appropriate material and strength class of table A1

fischer Injectionsystem FIS GREEN

Intended use
 Installation parameters internal threaded anchors RG MI

Annex B 3

| Rebar diameter | | | 8 ¹⁾ | 10 ¹⁾ | 12 ¹⁾ | 14 | 16 | 20 |
|--------------------------------------|---------------------|------|----------------------------------|------------------|------------------|-----------------------------------|-----|-----|
| Nominal drill hole diameter | d ₀ | [mm] | (10)12 | (12)14 | (14) 16 | 18 | 20 | 25 |
| Drill hole depth | h ₀ | [mm] | h ₀ = h _{ef} | | | | | |
| Effective anchorage depth | h _{ef,min} | [mm] | 60 | 60 | 70 | 75 | 80 | 90 |
| | h _{ef,max} | [mm] | 160 | 200 | 240 | 280 | 320 | 400 |
| Minimum spacing | s _{min} | [mm] | 40 | 45 | 55 | 60 | 65 | 85 |
| Minimum edge distance | c _{min} | [mm] | 40 | 45 | 55 | 60 | 65 | 85 |
| Minimum thickness of concrete member | h _{min} | [mm] | h _{ef} + 30 ≥ 100 | | | h _{ef} + 2d ₀ | | |

1) Both drill bit diameters can be used.

Reinforcing bar

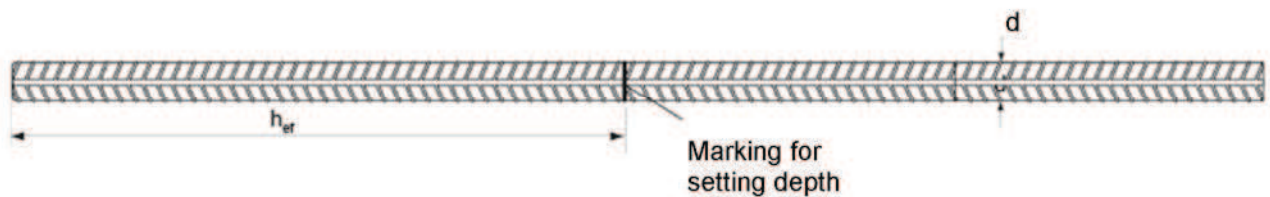

Properties of reinforcement: refer to EN 1992-1-1 Annex C, Table C.1 and C.2N

| Product form | | Non-zink-plated bars and deoiled rod | |
|---|-----------------------|--------------------------------------|------------------|
| Class | | B | C |
| Characteristic yield strength f_{yk} or $f_{0,2k}$ [MPa] | | 400 to 600 | |
| Minimum value of $k = (f_t/f_y)_k$ | | ≥ 1,08 | ≥ 1,15 < 1,35 |
| Characteristic strain at maximum force ϵ_{uk} [%] | | ≥ 5,0 | ≥ 7,5 |
| Bentability property | | Bend / Rebendtest | |
| Maximum deviation from nominal mass (individual bar) [%] | Nominal bar size [mm] | ≤ 8 | ± 6,0 |
| | | > 8 | ± 4,5 |
| Bond: Minimum relative rib area, $f_{R,min}$ (determination acc. to EN 15630) | Nominal bar size [mm] | 8 to 12 | 0,040 |
| | | > 12 | 0,056 |

Rib height h:

The rib height h must be: $0,05 * d \leq h \leq 0,07 * d$ d = nominal bar size

fischer Injectionsystem FIS GREEN

Intended use
Installation parameters reinforcing bars

Annex B 4

Table B4: Installation parameters rebar anchor FRA



| Threaded diameter | | | M12 ¹⁾ | M16 | M20 | |
|---|--------------------------|----------------|----------------------------------|----------------------------------|-----|----|
| Nominal bar size | d | [mm] | 12 | 16 | 20 | |
| Width across flat | SW | [mm] | 19 | 24 | 30 | |
| Nominal drill hole diameter | d ₀ | [mm] | (14) 16 | 20 | 25 | |
| Drill hole depth | h ₀ | [mm] | h _{ef} + ℓ _e | | | |
| Distance concrete surface to welded joint | ℓ _e | [mm] | 100 | | | |
| Effective anchorage depth | h _{ef,min} | [mm] | 70 | 80 | 90 | |
| | h _{ef,max} | [mm] | 140 | 220 | 300 | |
| Maximum torque moment | T _{inst,max} | [Nm] | 40 | 60 | 120 | |
| Minimum spacing | s _{min} | [mm] | 55 | 65 | 85 | |
| Minimum edge distance | c _{min} | [mm] | 55 | 65 | 85 | |
| Diameter of clearance hole in the fixture ²⁾ | Pre-positioned anchorage | d _f | [mm] | 14 | 18 | 22 |
| | Push-through anchorage | d _f | [mm] | 18 | 22 | 26 |
| Minimum thickness of concrete member | h _{min} | [mm] | h ₀ + 30 | h ₀ + 2d ₀ | | |

¹⁾ Both drill bit diameters can be used

²⁾ For bigger clearance holes in fixture see TR 029, chapter 1.1 or CEN/TS 1992-4-1, chapter 1.2.3

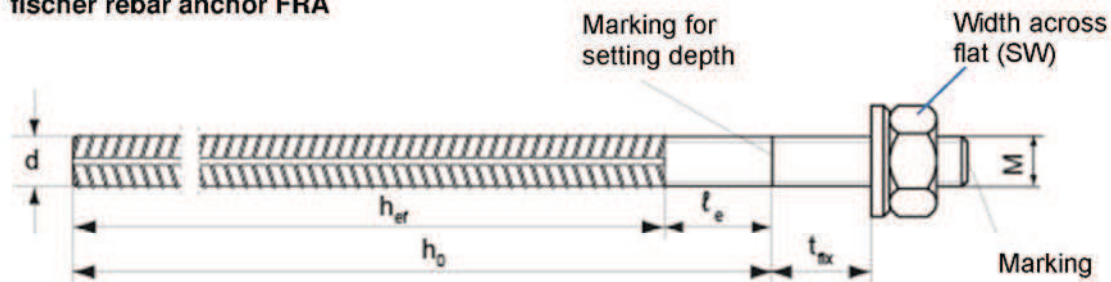
fischer rebar anchor FRA



Marking:  FRA (for stainless steel)
 FRA C (for high corrosion-resistant steel)

fischer Injectionsystem FIS GREEN

Intended use
 Installation parameters rebar anchor FRA

Annex B 5

Table B5: Parameters of steel brush FIS BS

| | | | | | | | | | |
|----------------------------|------|----|----|----|----|----|----|----|----|
| Drill bit diameter | [mm] | 10 | 12 | 14 | 16 | 18 | 20 | 24 | 25 |
| Steel brush diameter d_b | [mm] | 11 | 14 | 16 | 20 | 20 | 25 | 26 | 27 |

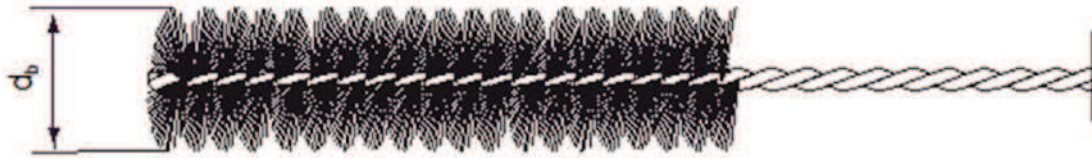

Cleaning nozzle

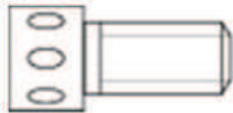
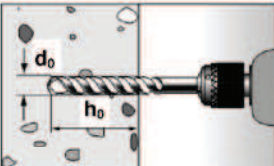
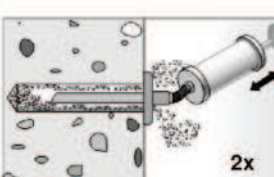
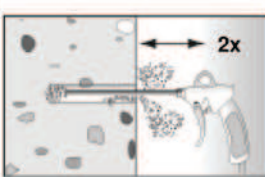
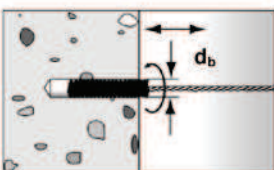
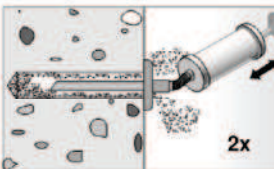
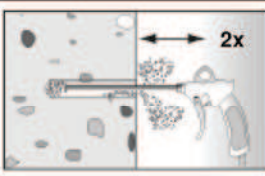

Table B6: Maximum processing time of the mortar and minimum curing time
(During the curing time of the mortar the concrete temperature may not fall below the listed minimum temperature).



| Temperature at anchoring base [°C] | Minimum curing time ¹⁾ t_{cure} [minutes] | System temperature (mortar) [°C] | Maximum processing time t_{work} [minutes] |
|--------------------------------------|--|------------------------------------|--|
| ±0 to +5 | 6 hours | +5 | 13 |
| >+5 to +10 | 4 hours | +10 | 9 |
| >+10 to +20 | 90 | +20 | 5 |
| >+20 to +30 | 60 | +30 | 4 |
| >+30 to +40 | 30 | +40 | 2 |

¹⁾ For wet concrete the curing time must be doubled.

Installation instructions part 1
Drilling and cleaning the hole

| | | | | |
|---|--|--|---|--|
| 1 |  | <p>Drill the hole. Drill hole diameter d_0 and drill hole depth h_0 see Tables B1, B2, B3, B4.</p> | | |
| 2 |  | <p>$h_{ef} \leq 10d$ and $d_0 < 18$ mm: Blow out the drill hole two times by hand.</p> |  | <p>$h_{ef} > 10d$ and/or $d_0 \geq 18$ mm: Blow out the drill hole two times, using oil-free pressure air ($p > 6$ bar) with a cleaning nozzle.</p> |
| 3 |  | <p>Brush the drill hole two times using an adequate steel brush (see Table B5).</p> | | |
| 4 |  | <p>$h_{ef} \leq 10d$ and $d_0 < 18$ mm: Blow out the drill hole two times by hand.</p> |  | <p>$h_{ef} > 10d$ and/or $d_0 \geq 18$ mm: Blow out the drill hole two times, using oil-free pressure air ($p > 6$ bar) with a cleaning nozzle.</p> |

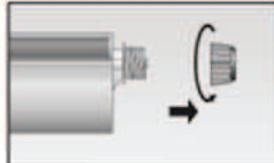
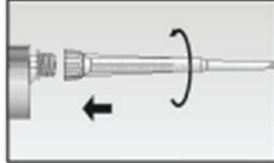
Preparing the cartridge

| | | | |
|---|---|--|--|
| 5 |  | <p>Twist off the sealing cap.</p> | |
| 6 |  | <p>Twist on the static mixer. The spiral in the static mixer must be clearly visible.</p> | |
| 7 |  | <p>Place the cartridge into the dispenser.</p> | |
| 8 |  | <p>Press out approx. 10cm of mortar until the resin is permanent grey in colour. Mortar which is not grey in colour will not cure and must be disposed of.</p> | |

fischer Injectionsystem FIS GREEN

Intended Use
Installation instructions part 1

Annex B 7

Installation instructions part 2
Injection of the mortar

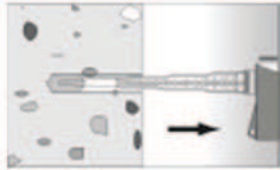
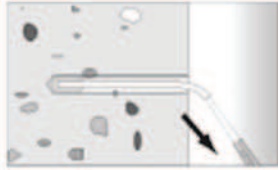
| | | | | |
|----------|---|---|--|---|
| 9 |  | <p>Fill approx. 2/3 of the drill hole with mortar. Always begin from the bottom of the hole to eliminate voids.</p> |  | <p>For drill hole depth ≥ 150 mm use an extension tube.</p> |
|----------|---|---|--|---|

Installation fischer anchor rods or internal threaded anchors RG MI

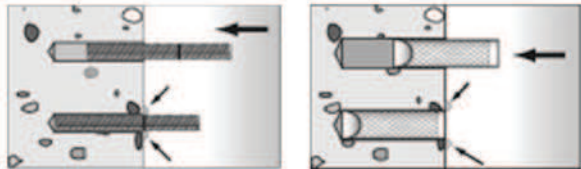
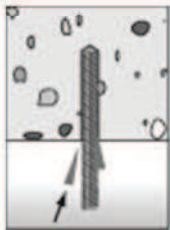
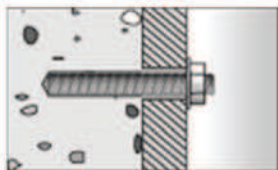
| | | | | |
|-----------|--|---|--|---|
| 10 |  | <p>Only use clean and oil-free anchor elements. Press the anchor rod or internal threaded anchor RG MI down to the bottom of the hole, turning it slightly while doing so. After inserting the anchor element, excess mortar must emerge around the anchor element.</p> | | |
| |  | <p>For overhead installation support the anchor element with wedges.</p> |  | <p>For push-through installation fill the annular gap also with mortar.</p> |

| | | |
|-----------|---|---|
| 11 |  | <p>Wait for the specified curing time t_{cure} see Table B6.</p> |
|-----------|---|---|

| | | |
|-----------|---|---|
| 12 |  | <p>Mounting the fixture $T_{inst,max}$ see Tables B1 or B6</p> |
|-----------|---|---|

Installing reinforcing bars and fischer rebar anchors FRA

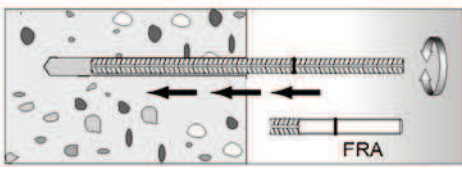
| | | |
|-----------|---|---|
| 10 |  | <p>Only use clean and oil-free rebars. Mark the reinforcing bar for setting depth. Using a turning movement, push the reinforcing bar or FRA vigorously into the filled hole up to the insertion depth marking. When reaching the setting depth marking surplus mortar must emerge around the anchor.</p> |
|-----------|---|---|

| | | |
|-----------|---|---|
| 11 |  | <p>Wait for the specified curing time t_{cure} see Table B6.</p> |
|-----------|---|---|

| | | |
|-----------|---|--|
| 12 |  | <p>Mounting the fixture $T_{inst,max}$ see Table B4</p> |
|-----------|---|--|

fischer Injectionsystem FIS GREEN

Intended Use
Installation instructions part 2

Annex B 8

Table C1: Characteristic values of resistance for threaded rods under tension loads in non-cracked concrete (Design according to TR 029)

| | | | | | | | |
|---|------------------------|----------------------|----------------------|------|-----|-----|-----|
| Anchor size | | | M8 | M10 | M12 | M16 | M20 |
| Installation safety factor | γ_2 | [-] | 1,2 | | | | |
| Combined pullout and concrete cone failure | | | | | | | |
| Diameter for calculation | d | [mm] | 8 | 10 | 12 | 16 | 20 |
| Characteristic bond resistance in non-cracked concrete C20/25 | | | | | | | |
| Temperature range I ¹⁾ | $\tau_{Rk,ucr}$ | [N/mm ²] | 10,5 | 10,0 | 9,5 | 8,5 | 7,5 |
| Temperature range II ¹⁾ | $\tau_{Rk,ucr}$ | [N/mm ²] | 9,5 | 9,0 | 8,5 | 7,5 | 6,5 |
| Increasing factor Ψ_c | C25/30 | [-] | 1,02 | | | | |
| | C30/37 | [-] | 1,04 | | | | |
| | C35/45 | [-] | 1,07 | | | | |
| | C40/50 | [-] | 1,08 | | | | |
| | C45/55 | [-] | 1,09 | | | | |
| | C50/60 | [-] | 1,10 | | | | |
| Splitting failure | | | | | | | |
| Edge distance $c_{cr,sp}$ | $h/h_{ef} \geq 2,0$ | [mm] | $1,0 h_{ef}$ | | | | |
| | $2,0 > h/h_{ef} > 1,3$ | [mm] | $4,6 h_{ef} - 1,8 h$ | | | | |
| | $h/h_{ef} \leq 1,3$ | [mm] | $2,26 h_{ef}$ | | | | |
| Spacing | $s_{cr,sp}$ | [mm] | $2 c_{cr,sp}$ | | | | |

¹⁾ See Annex B1

fischer Injectionsystem FIS GREEN

Performances

Characteristic values of resistance for threaded rods under tension load in non-cracked concrete. Design according to TR 029

Annex C 1

Table C2: Characteristic values of resistance for internal threaded anchors RG MI under tension loads in non-cracked concrete (Design according to TR 029)

| Anchor size | | | M8 | M10 | M12 | M16 | |
|---|------------------------|------|----------------------|------|-----|-----|-----|
| Installation safety factor | γ_2 | [-] | 1,2 | | | | |
| Steel failure | | | | | | | |
| Characteristic resistance with screw $N_{Rk,s}$ | Property class | 5.8 | [kN] | 19 | 29 | 43 | 79 |
| | | 8.8 | [kN] | 29 | 47 | 68 | 108 |
| | Property class 70 | A4 | [kN] | 26 | 41 | 59 | 110 |
| | | C | [kN] | 26 | 41 | 59 | 110 |
| Partial safety factor $\gamma_{Ms,N}^{1)}$ | Property class | 5.8 | [-] | 1,50 | | | |
| | | 8.8 | [-] | 1,50 | | | |
| | Property class 70 | A4 | [-] | 1,87 | | | |
| | | C | [-] | 1,87 | | | |
| Combined pullout and concrete cone failure | | | | | | | |
| Characteristic bond resistance in non-cracked concrete C20/25 | | | | | | | |
| Temperature range I ²⁾ | $N_{Rk,p}^0$ | [kN] | 32 | 38 | 56 | 76 | |
| Temperature range II ²⁾ | $N_{Rk,p}^0$ | [kN] | 30 | 35 | 51 | 70 | |
| Increasing factor Ψ_c | C25/30 | [-] | 1,02 | | | | |
| | C30/37 | [-] | 1,04 | | | | |
| | C35/45 | [-] | 1,07 | | | | |
| | C40/50 | [-] | 1,08 | | | | |
| | C45/55 | [-] | 1,09 | | | | |
| | C50/60 | [-] | 1,10 | | | | |
| Splitting failure | | | | | | | |
| Edge distance $c_{cr,sp}$ | $h/h_{ef} \geq 2,0$ | [mm] | 1,0 h_{ef} | | | | |
| | $2,0 > h/h_{ef} > 1,3$ | [mm] | 4,6 h_{ef} – 1,8 h | | | | |
| | $h/h_{ef} \leq 1,3$ | [mm] | 2,26 h_{ef} | | | | |
| Spacing | $s_{cr,sp}$ | [mm] | 2 $c_{cr,sp}$ | | | | |

¹⁾ In absence of other national regulations

²⁾ See Annex B1

fischer Injectionsystem FIS GREEN

Performances

Characteristic values of resistance for internal threaded rods under tension load in non-cracked concrete. (Design according to TR 029)

Annex C 2

Table C3: Characteristic values of resistance for reinforcing bars under tension loads in non-cracked concrete (Design according to TR 029)

| | | | | | | | | |
|---|------------------------|----------------------|----------------------|-----|-----|-----|-----|-----|
| Size | Ø | [mm] | 8 | 10 | 12 | 14 | 16 | 20 |
| Installation safety factor | γ_2 | [-] | 1,2 | | | | | |
| Combined pullout and concrete cone failure | | | | | | | | |
| Diameter of calculation | d | [mm] | 8 | 10 | 12 | 14 | 16 | 20 |
| Characteristic bond resistance in non-cracked concrete C20/25 | | | | | | | | |
| Temperature range I ²⁾ | $\tau_{Rk,ucr}$ | [N/mm ²] | 7,5 | 7,5 | 7,5 | 7,5 | 7,5 | 7,5 |
| Temperature range II ²⁾ | $\tau_{Rk,ucr}$ | [N/mm ²] | 6,5 | 6,5 | 6,5 | 6,5 | 6,5 | 6,5 |
| Increasing factor Ψ_c | C25/30 | [-] | 1,02 | | | | | |
| | C30/37 | [-] | 1,04 | | | | | |
| | C35/45 | [-] | 1,07 | | | | | |
| | C40/50 | [-] | 1,08 | | | | | |
| | C45/55 | [-] | 1,09 | | | | | |
| | C50/60 | [-] | 1,10 | | | | | |
| Splitting failure | | | | | | | | |
| Edge distance $c_{cr,sp}$ | $h/h_{ef} \geq 2,0$ | [mm] | 1,0 h_{ef} | | | | | |
| | $2,0 > h/h_{ef} > 1,3$ | [mm] | 4,6 $h_{ef} - 1,8 h$ | | | | | |
| | $h/h_{ef} \leq 1,3$ | [mm] | 2,26 h_{ef} | | | | | |
| Spacing | $s_{cr,sp}$ | [mm] | 2 $c_{cr,sp}$ | | | | | |

¹⁾ In absence of other national regulations

²⁾ See Annex B1

Table C4: Characteristic values of resistance for rebar anchors FRA under tension loads in non-cracked concrete (Design according to TR 029)

| | | | | | |
|---|-------------------------------|----------------------|----------------------|-----|-----|
| Size | | | M12 | M16 | M20 |
| Installation safety factor | γ_2 | [-] | 1,2 | | |
| Steel failure | | | | | |
| Characteristic resistance | $N_{Rk,s}$ | [kN] | 63 | 111 | 173 |
| Partial safety factor | $\gamma_{Ms,N}$ ¹⁾ | [-] | 1,40 | | |
| Combined pullout and concrete cone failure | | | | | |
| Diameter of calculation | d | [mm] | 12 | 16 | 20 |
| Characteristic bond resistance in non-cracked concrete C20/25 | | | | | |
| Temperature range I ²⁾ | $\tau_{Rk,ucr}$ | [N/mm ²] | 7,5 | 7,5 | 7,5 |
| Temperature range II ²⁾ | $\tau_{Rk,ucr}$ | [N/mm ²] | 6,5 | 6,5 | 6,5 |
| Increasing factor Ψ_c | C25/30 | [-] | 1,02 | | |
| | C30/37 | [-] | 1,04 | | |
| | C35/45 | [-] | 1,07 | | |
| | C40/50 | [-] | 1,08 | | |
| | C45/55 | [-] | 1,09 | | |
| | C50/60 | [-] | 1,10 | | |
| Splitting failure | | | | | |
| Edge distance $c_{cr,sp}$ | $h/h_{ef} \geq 2,0$ | [mm] | 1,0 h_{ef} | | |
| | $2,0 > h/h_{ef} > 1,3$ | [mm] | 4,6 $h_{ef} - 1,8 h$ | | |
| | $h/h_{ef} \leq 1,3$ | [mm] | 2,26 h_{ef} | | |
| Spacing | $s_{cr,sp}$ | [mm] | 2 $c_{cr,sp}$ | | |

¹⁾ In absence of other national regulations

²⁾ See Annex B1

fischer Injectionsystem FIS GREEN

Performances

Characteristic values of resistance for reinforcing bars and rebar anchors FRA under tension load in non-cracked concrete. (Design according to TR 029)

Annex C 3

Table C5: Characteristic values of resistance for threaded rods under shear loads in non-cracked concrete (Design according to TR 029)

| Size | M8 | M10 | M12 | M16 | M20 |
|--|----|-----|-----|-----|-----|
| Concrete pryout failure | | | | | |
| Factor k in equation (5.7) of Technical Report TR 029, Section 5.2.3.3 | k | [-] | 2,0 | | |

Table C6: Characteristic values of resistance for internal threaded rods RG MI under shear loads in non-cracked concrete (Design according to TR 029)

| Size | M8 | M10 | M12 | M16 | | | |
|--|-------------------|-----|------|------|------|------|------|
| Steel failure without lever arm | | | | | | | |
| Characteristic resistance $V_{Rk,s}$ | Property class | 5.8 | [kN] | 9,2 | 14,5 | 21,1 | 39,2 |
| | | 8.8 | [kN] | 14,6 | 23,2 | 33,7 | 62,7 |
| | Property class 70 | A4 | [kN] | 12,8 | 20,3 | 29,5 | 54,8 |
| | | C | [kN] | 12,8 | 20,3 | 29,5 | 54,8 |
| Steel failure with lever arm | | | | | | | |
| Characteristic resistance $M^0_{Rk,s}$ | Property class | 5.8 | [Nm] | 20 | 39 | 68 | 173 |
| | | 8.8 | [Nm] | 30 | 60 | 105 | 266 |
| | Property class 70 | A4 | [Nm] | 26 | 52 | 92 | 232 |
| | | C | [Nm] | 26 | 52 | 92 | 232 |
| Concrete pryout failure | | | | | | | |
| Factor k in equation (5.7) of Technical Report TR 029, Section 5.2.3.3 | k | [-] | 2,0 | | | | |

fischer Injectionsystem FIS GREEN**Performances**

Characteristic values of resistance for threaded rods and internal threaded anchors RG MI under shear loads in non-cracked concrete (Design according to TR 029)

Annex C 4

Table C7: Characteristic values of resistance for reinforcing bars under shear loads in non-cracked concrete (Design according to TR 029)

| Size | Ø | [mm] | 8 | 10 | 12 | 14 | 16 | 20 |
|--|---|------|-----|----|----|----|----|----|
| Concrete pryout failure | | | | | | | | |
| Factor k in equation (5.7) of Technical Report TR 029, Section 5.2.3.3 | k | [-] | 2,0 | | | | | |

Table C8: Characteristic values of resistance rebar anchors FRA under shear loads in non-cracked concrete (Design according to TR 029)

| Size | | | M12 | M16 | M20 |
|--|-------------------------------|------|------|-----|-----|
| Steel failure without lever arm | | | | | |
| Characteristic resistance | $V_{Rk,s}$ | [kN] | 30 | 55 | 86 |
| Steel failure with lever arm | | | | | |
| Characteristic resistance | $M^0_{Rk,s}$ | [Nm] | 92 | 233 | 454 |
| Partial safety factor | $\gamma_{Ms,v}$ ¹⁾ | [-] | 1,56 | | |
| Concrete pryout failure | | | | | |
| Factor k in equation (5.7) of Technical Report TR 029, Section 5.2.3.3 | k | [-] | 2,0 | | |

¹⁾ In absence of other national regulations

fischer Injectionsystem FIS GREEN

Performances

Characteristic values of resistance for reinforcing bars and rebar anchors FRA under shear loads in non-cracked concrete (Design according to TR 029)

Annex C 5

Table C9: Characteristic values of resistance for threaded rods under tension loads in non-cracked concrete (Design according to CEN/TS 1992-4)

| | | | | | | | |
|---|------------------------|----------------------|----------------------|------|-----|-----|-----|
| Anchor size | | | M8 | M10 | M12 | M16 | M20 |
| Installation safety factor | γ_{inst} | [-] | 1,2 | | | | |
| Steel failure | | | | | | | |
| Characteristic resistance | $N_{Rk,s}$ | [kN] | $A_s \times f_{uk}$ | | | | |
| Combined pullout and concrete cone failure | | | | | | | |
| Diameter for calculation | d | [mm] | 8 | 10 | 12 | 16 | 20 |
| Characteristic bond resistance in non-cracked concrete C20/25 | | | | | | | |
| Temperature range I ¹⁾ | $\tau_{Rk,ucr}$ | [N/mm ²] | 10,5 | 10,0 | 9,5 | 8,5 | 7,5 |
| Temperature range II ¹⁾ | $\tau_{Rk,ucr}$ | [N/mm ²] | 9,5 | 9,0 | 8,5 | 7,5 | 6,5 |
| Increasing factor Ψ_c | C25/30 | [-] | 1,02 | | | | |
| | C30/37 | [-] | 1,04 | | | | |
| | C35/45 | [-] | 1,07 | | | | |
| | C40/50 | [-] | 1,08 | | | | |
| | C45/55 | [-] | 1,09 | | | | |
| | C50/60 | [-] | 1,10 | | | | |
| Factor acc. CEN/TS-1992-4 Section 6.2.2.3 | k_8 | [-] | 10,1 | | | | |
| Splitting failure | | | | | | | |
| Factor acc. CEN/TS-1992-4 Section 6.2.3.1 | k_{ucr} | [-] | 10,1 | | | | |
| Edge distance $c_{cr,sp}$ | $h/h_{ef} \geq 2,0$ | [mm] | $1,0 h_{ef}$ | | | | |
| | $2,0 > h/h_{ef} > 1,3$ | [mm] | $4,6 h_{ef} - 1,8 h$ | | | | |
| | $h/h_{ef} \leq 1,3$ | [mm] | $2,26 h_{ef}$ | | | | |
| Spacing | $s_{cr,sp}$ | [mm] | $2 c_{cr,sp}$ | | | | |

¹⁾ See Annex B1

fischer Injectionsystem FIS GREEN

Performances

Characteristic values of resistance for threaded rods under tension load in non-cracked concrete. Design according to CEN/TS-1992-4

Annex C 6

Table C10: Characteristic values of resistance for internal threaded anchors RG MI under tension loads in non-cracked concrete (Design according to CEN/TS 1992-4)

| Anchor size | | | M8 | M10 | M12 | M16 | |
|---|------------------------|------|----------------------|------|-----|-----|-----|
| Installation safety factor | γ_{inst} | [-] | 1,2 | | | | |
| Steel failure | | | | | | | |
| Characteristic resistance with screw $N_{Rk,s}$ | Property class | 5.8 | [kN] | 19 | 29 | 43 | 79 |
| | | 8.8 | [kN] | 29 | 47 | 68 | 108 |
| | Property class 70 | A4 | [kN] | 26 | 41 | 59 | 110 |
| | | C | [kN] | 26 | 41 | 59 | 110 |
| Partial safety factor $\gamma_{Ms,N}^{1)}$ | Property class | 5.8 | [-] | 1,50 | | | |
| | | 8.8 | [-] | 1,50 | | | |
| | Property class 70 | A4 | [-] | 1,87 | | | |
| | | C | [-] | 1,87 | | | |
| Combined pullout and concrete cone failure | | | | | | | |
| Characteristic bond resistance in non-cracked concrete C20/25 | | | | | | | |
| Temperature range I ²⁾ | $N_{Rk,p}^0$ | [kN] | 32 | 38 | 56 | 76 | |
| Temperature range II ²⁾ | $N_{Rk,p}^0$ | [kN] | 30 | 35 | 51 | 70 | |
| Increasing factor Ψ_c | C25/30 | [-] | 1,02 | | | | |
| | C30/37 | [-] | 1,04 | | | | |
| | C35/45 | [-] | 1,07 | | | | |
| | C40/50 | [-] | 1,08 | | | | |
| | C45/55 | [-] | 1,09 | | | | |
| | C50/60 | [-] | 1,10 | | | | |
| Factor acc. CEN/TS-1992-4-5:2009 Section 6.2.2.3 | k_8 | [-] | 10,1 | | | | |
| Splitting failure | | | | | | | |
| Factor acc. CEN/TS-1992-4-5:2009 Section 6.2.3.1 | k_{ucr} | [-] | 10,1 | | | | |
| Edge distance $c_{cr,sp}$ | $h/h_{ef} \geq 2,0$ | [mm] | $1,0 h_{ef}$ | | | | |
| | $2,0 > h/h_{ef} > 1,3$ | [mm] | $4,6 h_{ef} - 1,8 h$ | | | | |
| | $h/h_{ef} \leq 1,3$ | [mm] | $2,26 h_{ef}$ | | | | |
| Spacing | $s_{cr,sp}$ | [mm] | $2 c_{cr,sp}$ | | | | |

¹⁾ In absence of other national regulations

²⁾ See Annex B1

fischer Injectionsystem FIS GREEN

Performances

Characteristic values of resistance for internal threaded rods RG MI under tension load in non-cracked concrete. Design according to CEN/TS-1992-4

Annex C 7

Table C11: Characteristic values of resistance for reinforcing bars under tension loads in non-cracked concrete (Design according to CEN/TS 1992-4)

| Size | \varnothing | [mm] | 8 | 10 | 12 | 14 | 16 | 20 |
|---|------------------------|----------------------|----------------------|-----|-----|-----|-----|-----|
| Installation safety factor | γ_{inst} | [-] | 1,2 | | | | | |
| Steel failure | | | | | | | | |
| Characteristic resistance | $N_{Rk,s}$ | [kN] | $A_s \times f_{uk}$ | | | | | |
| Combined pullout and concrete cone failure | | | | | | | | |
| Diameter of calculation | d | [mm] | 8 | 10 | 12 | 14 | 16 | 20 |
| Characteristic bond resistance in non-cracked concrete C20/25 | | | | | | | | |
| Temperature range I ¹⁾ | $\tau_{Rk,ucr}$ | [N/mm ²] | 7,5 | 7,5 | 7,5 | 7,5 | 7,5 | 7,5 |
| Temperature range II ¹⁾ | $\tau_{Rk,ucr}$ | [N/mm ²] | 6,5 | 6,5 | 6,5 | 6,5 | 6,5 | 6,5 |
| Increasing factor Ψ_c | C25/30 | [-] | 1,02 | | | | | |
| | C30/37 | [-] | 1,04 | | | | | |
| | C35/45 | [-] | 1,07 | | | | | |
| | C40/50 | [-] | 1,08 | | | | | |
| | C45/55 | [-] | 1,09 | | | | | |
| | C50/60 | [-] | 1,10 | | | | | |
| Factor acc. CEN/TS-1992-4-5:2009 Section 6.2.2.3 | k_8 | [-] | 10,1 | | | | | |
| Splitting failure | | | | | | | | |
| Factor acc. CEN/TS-1992-4-5:2009 Section 6.2.3.1 | k_{ucr} | [-] | 10,1 | | | | | |
| Edge distance $c_{cr,sp}$ | $h/h_{ef} \geq 2,0$ | [mm] | $1,0 h_{ef}$ | | | | | |
| | $2,0 > h/h_{ef} > 1,3$ | [mm] | $4,6 h_{ef} - 1,8 h$ | | | | | |
| | $h/h_{ef} \leq 1,3$ | [mm] | $2,26 h_{ef}$ | | | | | |
| Spacing | $s_{cr,sp}$ | [mm] | $2 c_{cr,sp}$ | | | | | |

¹⁾ See Annex B1

fischer Injectionsystem FIS GREEN

Performances

Characteristic values of resistance for reinforcing bars under tension load in non-cracked concrete. Design according to CEN/TS-1992-4

Annex C 8

Table C12: Characteristic values of resistance for rebar anchors FRA under tension loads in non-cracked concrete (Design according to CEN/TS 1992-4)

| Size | | | M12 | M16 | M20 |
|---|-------------------------------|----------------------|----------------------|-----|-----|
| Installation safety factor | γ_{inst} | [-] | 1,2 | | |
| Steel failure | | | | | |
| Characteristic resistance | $N_{Rk,s}$ | [kN] | 63 | 111 | 173 |
| Partial safety factor | $\gamma_{Ms,N}$ ¹⁾ | [-] | 1,40 | | |
| Combined pullout and concrete cone failure | | | | | |
| Diameter of calculation | d | [mm] | 12 | 16 | 20 |
| Characteristic bond resistance in non-cracked concrete C20/25 | | | | | |
| Temperature range I ²⁾ | $\tau_{Rk,ucr}$ | [N/mm ²] | 7,5 | 7,5 | 7,5 |
| Temperature range II ²⁾ | $\tau_{Rk,ucr}$ | [N/mm ²] | 6,5 | 6,5 | 6,5 |
| Increasing factor Ψ_c | C25/30 | [-] | 1,02 | | |
| | C30/37 | [-] | 1,04 | | |
| | C35/45 | [-] | 1,07 | | |
| | C40/50 | [-] | 1,08 | | |
| | C45/55 | [-] | 1,09 | | |
| | C50/60 | [-] | 1,10 | | |
| Factor acc. CEN/TS-1992-4-5:2009 Section 6.2.2.3 | k_8 | [-] | 10,1 | | |
| Splitting failure | | | | | |
| Factor acc. CEN/TS-1992-4-5:2009 Section 6.2.3.1 | k_{ucr} | [-] | 10,1 | | |
| Edge distance $c_{cr,sp}$ | $h/h_{ef} \geq 2,0$ | [mm] | $1,0 h_{ef}$ | | |
| | $2,0 > h/h_{ef} > 1,3$ | [mm] | $4,6 h_{ef} - 1,8 h$ | | |
| | $h/h_{ef} \leq 1,3$ | [mm] | $2,26 h_{ef}$ | | |
| Spacing | $s_{cr,sp}$ | [mm] | $2 c_{cr,sp}$ | | |

¹⁾ In absence of other national regulations

²⁾ See Annex B1

fischer Injectionsystem FIS GREEN

Performances

Characteristic values of resistance for rebar anchors FRA under tension load in non-cracked concrete. Design according to CEN/TS-1992-4

Annex C 9

Table C13: Characteristic values of resistance for threaded rods under shear loads in non-cracked concrete (Design according to CEN/TS 1992-4)

| Size | | | M8 | M10 | M12 | M16 | M20 |
|---|-----------------|------|-----------------------------------|-----|-----|-----|-----|
| Installation safety factor | γ_{inst} | [-] | 1,0 | | | | |
| Steel failure without lever arm | | | | | | | |
| Characteristic resistance | $V_{Rk,s}$ | [kN] | $0,5 A_s \times f_{uk}$ | | | | |
| Ductility factor acc. to CEN/TS 1992-4-5, Section 6.3.2.1 | k_2 | [-] | 0,8 | | | | |
| Steel failure with lever arm | | | | | | | |
| Characteristic resistance | $M^0_{Rk,s}$ | [Nm] | $1,2 \times W_{el} \times f_{uk}$ | | | | |
| Concrete pryout failure | | | | | | | |
| Factor in equation of CEN/TS 1992-4-5, Section 6.3.3 | k_3 | [-] | 2,0 | | | | |
| Concrete edge failure | | | | | | | |
| Effective length of anchor | l_f | [mm] | $l_f = \min(h_{ef}, 8 d_{nom})$ | | | | |
| Outside diameter of anchor | d_{nom} | [mm] | 8 | 10 | 12 | 16 | 20 |

Table C14: Characteristic values of resistance for internal threaded rods RG MI under shear loads in non-cracked concrete (Design according to CEN/TS 1992-4)

| Size | | | M8 | M10 | M12 | M16 | |
|---|-------------------|------|------|------|------|------|------|
| Installation safety factor | γ_{inst} | [-] | 1,0 | | | | |
| Steel failure without lever arm | | | | | | | |
| Characteristic resistance $V_{Rk,s}$ | Property class | 5.8 | [kN] | 9,2 | 14,5 | 21,1 | 39,2 |
| | | 8.8 | [kN] | 14,6 | 23,2 | 33,7 | 62,7 |
| | Property class 70 | A4 | [kN] | 12,8 | 20,3 | 29,5 | 54,8 |
| | | C | [kN] | 12,8 | 20,3 | 29,5 | 54,8 |
| Ductility factor acc. to CEN/TS 1992-4-5, Section 6.3.2.1 | k_2 | [-] | 0,8 | | | | |
| Steel failure with lever arm | | | | | | | |
| Characteristic resistance $M^0_{Rk,s}$ | Property class | 5.8 | [Nm] | 20 | 39 | 68 | 173 |
| | | 8.8 | [Nm] | 30 | 60 | 105 | 266 |
| | Property class 70 | A4 | [Nm] | 26 | 52 | 92 | 232 |
| | | C | [Nm] | 26 | 52 | 92 | 232 |
| Concrete pryout failure | | | | | | | |
| Factor in equation of CEN/TS 1992-4-5, Section 6.3.3 | k_3 | [-] | 2,0 | | | | |
| Concrete edge failure | | | | | | | |
| Effective length of anchor | l_f | [mm] | 90 | 90 | 125 | 160 | |
| Outside diameter of anchor | d_{nom} | [mm] | 12 | 16 | 18 | 22 | |

fischer Injectionsystem FIS GREEN**Performances**

Characteristic values of resistance for threaded rods and internal threaded anchors RG MI under shear loads in non-cracked concrete (Design according to CEN/TS

Annex C 10

Table C15: Characteristic values of resistance for reinforcing bars under shear loads in non-cracked concrete (Design according to CEN/TS 1992-4)

| | | | | | | | | |
|---|-----------------|------|-----------------------------------|----|----|----|----|----|
| Size | $\varnothing d$ | [mm] | 8 | 10 | 12 | 14 | 16 | 20 |
| Installation safety factor | γ_{inst} | [-] | 1,0 | | | | | |
| Steel failure without lever arm | | | | | | | | |
| Characteristic resistance | $V_{Rk,s}$ | [kN] | 0,5 $A_s \times f_{uk}$ | | | | | |
| Ductility factor acc. to CEN/TS 1992-4-5, Section 6.3.2.1 | k_2 | [-] | 0,8 | | | | | |
| Steel failure with lever arm | | | | | | | | |
| Characteristic resistance | $M^0_{Rk,s}$ | [Nm] | 1,2 $\times W_{el} \times f_{uk}$ | | | | | |
| Concrete pryout failure | | | | | | | | |
| Factor in equation of CEN/TS 1992-4-5, Section 6.3.3 | k_3 | [-] | 2,0 | | | | | |
| Concrete edge failure | | | | | | | | |
| Effective length of anchor | l_f | [mm] | $l_f = \min(h_{ef}, 8d_{nom})$ | | | | | |
| Outside diameter of anchor | d_{nom} | [mm] | 8 | 10 | 12 | 14 | 16 | 20 |

Table C16: Characteristic values of resistance rebar anchors FRA under shear loads in non-cracked concrete (Design according to CEN/TS 1992-4)

| | | | | | |
|---|-------------------------------|------|------|-----|-----|
| Size | | | M12 | M16 | M20 |
| Installation safety factor | γ_{inst} | [-] | 1,0 | | |
| Steel failure without lever arm | | | | | |
| Characteristic resistance | $V_{Rk,s}$ | [kN] | 30 | 55 | 86 |
| Ductility factor acc. to CEN/TS 1992-4-5, Section 6.3.2.1 | k_2 | [-] | 0,8 | | |
| Steel failure with lever arm | | | | | |
| Characteristic resistance | $M^0_{Rk,s}$ | [Nm] | 92 | 233 | 454 |
| Partial safety factor | $\gamma_{Ms,v}$ ¹⁾ | [-] | 1,56 | | |
| Concrete pryout failure | | | | | |
| Factor in equation of CEN/TS 1992-4-5, Section 6.3.3 | k_3 | [-] | 2,0 | | |
| Concrete edge failure | | | | | |
| Effective length of anchor | l_f | [mm] | | | |
| Outside diameter of anchor | d_{nom} | [mm] | 12 | 16 | 20 |

¹⁾ In absence of other national regulations

fischer Injectionsystem FIS GREEN

Performances

Characteristic values of resistance for reinforcing bars and rebar anchors FRA under shear loads in non-cracked concrete (Design according to CEN/TS 1992-4)

Annex C 11

Table C17: Displacements under tension load¹⁾ for threaded rods

| Size | | M8 | M10 | M12 | M16 | M20 |
|-----------------------------------|---------------------------|------|------|------|------|------|
| Temperature range I and II | | | | | | |
| δ_{N0} -Factor | [mm/(N/mm ²)] | 0,09 | 0,09 | 0,10 | 0,11 | 0,11 |
| $\delta_{N\infty}$ -Factor | [mm/(N/mm ²)] | 0,14 | 0,14 | 0,15 | 0,17 | 0,17 |

¹⁾ Calculation of the displacement

$$\delta_{N0} = \delta_{N0}\text{-Factor} \cdot \tau$$

$$\delta_{N\infty} = \delta_{N\infty}\text{-Factor} \cdot \tau$$

Table C18: Displacements under shear load¹⁾ for threaded rods

| Size | | M8 | M10 | M12 | M16 | M20 |
|-----------------------------------|---------|------|------|------|------|------|
| Temperature range I and II | | | | | | |
| δ_{V0} -Factor | [mm/kN] | 0,18 | 0,15 | 0,12 | 0,09 | 0,07 |
| $\delta_{V\infty}$ -Factor | [mm] | 0,27 | 0,22 | 0,18 | 0,14 | 0,11 |

¹⁾ Calculation of the displacement

$$\delta_{N0} = \delta_{N0}\text{-Factor} \cdot V$$

$$\delta_{N\infty} = \delta_{N\infty}\text{-Factor} \cdot V$$

Table C19: Displacements under tension load¹⁾ for internal threaded anchors RG MI

| Size | | M8 | M10 | M12 | M16 |
|-----------------------------------|---------------------------|------|------|------|------|
| Temperature range I and II | | | | | |
| δ_{N0} -Factor | [mm/(N/mm ²)] | 0,10 | 0,11 | 0,12 | 0,12 |
| $\delta_{N\infty}$ -Factor | [mm/(N/mm ²)] | 0,15 | 0,17 | 0,18 | 0,18 |

¹⁾ Calculation of the displacement

$$\delta_{N0} = \delta_{N0}\text{-Factor} \cdot \tau$$

$$\delta_{N\infty} = \delta_{N\infty}\text{-Factor} \cdot \tau$$

Table C20: Displacements under shear load¹⁾ for internal threaded anchors RG MI

| Size | | M8 | M10 | M12 | M16 |
|-----------------------------------|---------|------|------|------|------|
| Temperature range I and II | | | | | |
| δ_{V0} -Factor | [mm/kN] | 0,18 | 0,15 | 0,12 | 0,09 |
| $\delta_{V\infty}$ -Factor | [mm/kN] | 0,27 | 0,22 | 0,18 | 0,14 |

¹⁾ Calculation of the displacement

$$\delta_{N0} = \delta_{N0}\text{-Factor} \cdot V$$

$$\delta_{N\infty} = \delta_{N\infty}\text{-Factor} \cdot V$$

fischer Injectionsystem FIS GREEN

Performances
Displacements threaded rods and internal threaded anchor

Annex C 12

Table C21: Displacements under tension load¹⁾ for reinforcing bars

| Size | Ø | [mm] | 8 | 10 | 12 | 14 | 16 | 20 |
|-----------------------------------|---|---------------------------|------|------|------|------|------|------|
| Temperature range I and II | | | | | | | | |
| δ _{N0} -Factor | | [mm/(N/mm ²)] | 0,09 | 0,09 | 0,10 | 0,11 | 0,12 | 0,13 |
| δ _{N∞} -Factor | | [mm/(N/mm ²)] | 0,13 | 0,14 | 0,16 | 0,16 | 0,18 | 0,20 |

¹⁾ Calculation of the displacement

$$\delta_{N0} = \delta_{N0}\text{-Factor} \cdot \tau$$

$$\delta_{N\infty} = \delta_{N\infty}\text{-Factor} \cdot \tau$$

Table C22: Displacements under shear load¹⁾ for reinforcing bars

| Size | Ø | [mm] | 8 | 10 | 12 | 14 | 16 | 20 |
|---|---|---------|------|------|------|------|------|------|
| Temperature range I (-40°C / +40°C) and temperature range II (-40°C / +80°C) | | | | | | | | |
| δ _{V0} -Factor | | [mm/kN] | 0,18 | 0,15 | 0,12 | 0,10 | 0,09 | 0,07 |
| δ _{V∞} -Factor | | [mm/kN] | 0,27 | 0,22 | 0,18 | 0,16 | 0,14 | 0,11 |

¹⁾ Calculation of the displacement

$$\delta_{N0} = \delta_{N0}\text{-Factor} \cdot V$$

$$\delta_{N\infty} = \delta_{N\infty}\text{-Factor} \cdot V$$

Table C23: Displacements under tension load¹⁾ for rebar anchor FRA

| Size | Ø | [mm] | M10 | M12 | M16 |
|-----------------------------------|---|---------------------------|------|------|------|
| Temperature range I and II | | | | | |
| δ _{N0} -Factor | | [mm/(N/mm ²)] | 0,09 | 0,10 | 0,12 |
| δ _{N∞} -Factor | | [mm/(N/mm ²)] | 0,14 | 0,16 | 0,18 |

¹⁾ Calculation of the displacement

$$\delta_{N0} = \delta_{N0}\text{-Factor} \cdot \tau$$

$$\delta_{N\infty} = \delta_{N\infty}\text{-Factor} \cdot \tau$$

Table C24: Displacements under shear load¹⁾ for rebar anchor FRA

| Size | Ø | [mm] | M10 | M12 | M16 |
|-----------------------------------|---|---------|------|------|------|
| Temperature range I and II | | | | | |
| δ _{V0} -Factor | | [mm/kN] | 0,15 | 0,12 | 0,09 |
| δ _{V∞} -Factor | | [mm/kN] | 0,22 | 0,18 | 0,14 |

¹⁾ Calculation of the displacement

$$\delta_{N0} = \delta_{N0}\text{-Factor} \cdot V$$

$$\delta_{N\infty} = \delta_{N\infty}\text{-Factor} \cdot V$$

fischer Injectionsystem FIS GREEN

Performances
Displacements reinforcing bars and rebar anchor FRA

Annex C 13